

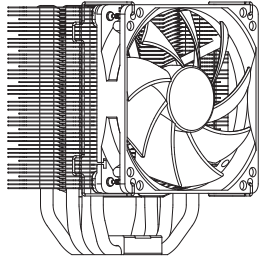

INSTALLATION GUIDE

安装说明书

This installation guide is applicable for all ICE BLADE series.
此说明书适用于九州风神冰刃系列产品。



PRODUCT SCHEMATIC DRAWING
产品示意图

CAUTION:

1. All specifications and pictures in this installation guide are for reference only. Please refer to your product for acutality.
2. Under no condition shall Deepcool be liable for any indirect, incidental or consequential damages arising from any defect or error in this manual or product.
3. Please ask for professional help if you are not sure of safe installation.
4. Installation manual in other languages is available on our website: www.deepcoolglobal.com.

警告声明：

1. 本公司有权在未事先通知的情况下对本说明书进行修改，以便改进产品的稳定性、设计及功能。
2. 本说明书之描述内容不代表本公司之承诺，对于任何因安装或使用不当而造成直接、间接、有意、无意的损坏及隐患，本公司概不负责。
3. 在无法掌握操作方法前需请求专业人士帮助，严禁在未掌握操作要领的前提下使用本产品。
4. 若需对本公司产品了解更多信息，请浏览我们的网页：www.deepcoolglobal.com

COMPONENTS LIST 零部件说明

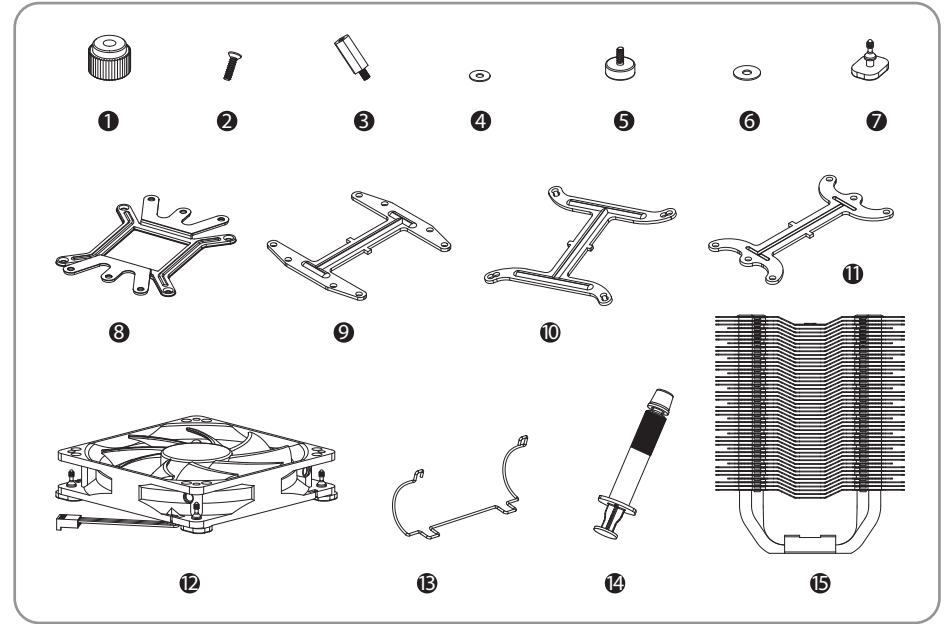

①	Nut	螺母	4pcs
②	Thumb Screw	螺丝	4pcs
③	Hex-head Nut	六角螺母	4pcs
④	Washer	垫片	4pcs
⑤	Rivet Nut	背铆钉	4pcs
⑥	Insulation Pad	绝缘胶垫	4pcs
⑦	Divibration Buckle	减震器	8pcs
⑧	Back Plate	背板	1pc
⑨	Retention Bracket (Intel LGA775)	工型扣具 (Intel LGA775)	1pc
⑩	Retention Bracket (Intel LGA1366/1156/1155)	工型扣具 (Intel LGA1366/1156/1155)	1pc
⑪	Retention Bracket (AMD K8)	工型扣具 (AMD K8)	1pc
⑫	Fan 120mm	120mm风扇	1pc
⑬	Fan Wire Clip	钢丝扣	4pcs
⑭	Thermal Grease	针管导热膏	1pc
⑮	Heatsink Set	散热器主体	1pc

Extra Components for Second Fan Assembly:
Fan Wire Clip
De-Vibration Buckle

Intel LGA775 Installation Intel LGA775安装步骤

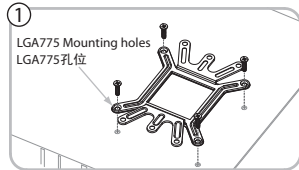

Put the back plate onto the back of the motherboard and insert the thumb screws through the LGA775 mounting holes.
如图所示，放好背板，将螺丝穿过背板对应的LGA775孔位。

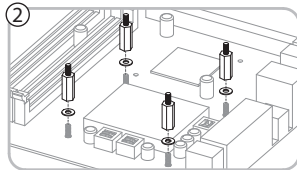

Slip the washers on the thumb screws protruding out of the motherboard, and thread the hex-head nuts on the screws to secure the back plate.
如图所示，将垫片穿过主板上的螺丝，然后用六角螺母锁紧背板。

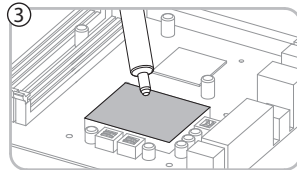

Evenly apply a thin layer of thermal grease onto the processor.
将导热膏均匀涂在CPU表面。

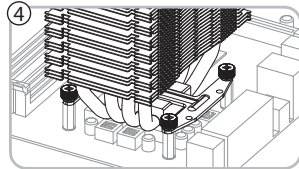

Put the heatsink onto the processor, and put the retention bracket (Intel LGA775) across the heatsink base, then secure the heatsink by threading the thumb screws into the hex-head nuts.
将散热器主体放在CPU上，注意底部与CPU表面完全接触，然后放入工型扣具Intel LGA775，使其LGA775孔位穿过六角螺母顶端，然后用螺母锁紧工型扣具Intel LGA775。

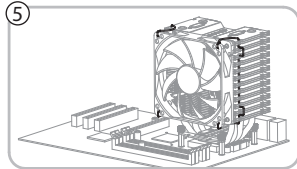

Fix the De-Vibration Buckle onto the fan and attach the fan to the heatsink with wire clips.
用钢丝扣把装好减震器的风扇安装固定在散热器主体一侧。

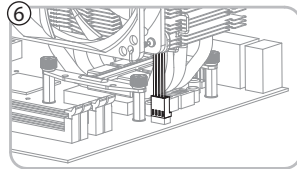

Finish the installation by connecting the fan cable to the motherboard.
将风扇端子插在主板相应位置，确认无误后完成安装。

Intel LGA1366/1156/1155 Installation Intel LGA1366/1156/1155安装步骤

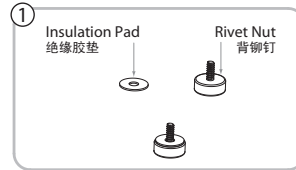

Peel off the film of insulating washer from one side and stick it onto the rivets.
撕开绝缘胶垫一面胶纸，贴在背铆钉上面。

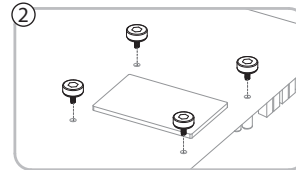

Peel off the other film of insulating washers, and stick them onto the back of the motherboard.
撕开绝缘胶垫另一面胶纸，将背铆钉对准主板孔位放置，压紧。

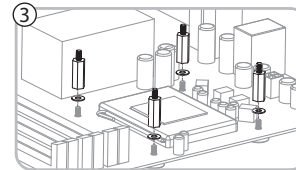

Slip the washers on the thumb screws protruding out of the motherboard, and thread the hex-head nuts on the screws to secure the back plate.
如图所示，将垫片穿过主板上的螺丝，然后用六角螺母锁紧背板。

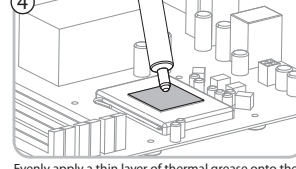

Evenly apply a thin layer of thermal grease onto the processor.
将导热膏均匀涂在CPU表面。

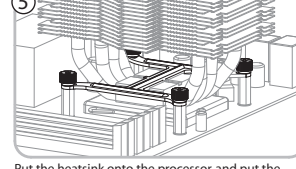

Put the heatsink onto the processor, and put the retention bracket (Intel LGA1366/1156/1155) across the heatsink base, then secure the heatsink by threading the thumb screws into the hex-head nuts.
将散热器主体放在CPU上，注意底部与CPU表面完全接触，然后放入工型扣具Intel LGA1366/1156/1155，使其对应孔位穿过六角螺母顶端，然后用螺母锁紧工型扣具Intel LGA1366/1156/1155。

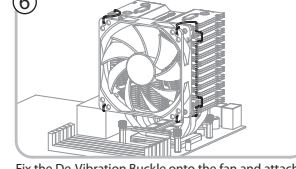

Fix the De-Vibration Buckle onto the fan and attach the fan to the heatsink with wire clips.
用钢丝扣把装好减震器的风扇安装固定在散热器主体一侧。

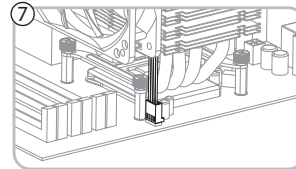

Finish the installation by connecting the fan cable to the motherboard.
将风扇端子插在主板相应位置，确认无误后完成安装。

AMD AM3/AM2+/AM2 Installation AMD AM3/AM2+/AM2安装步骤

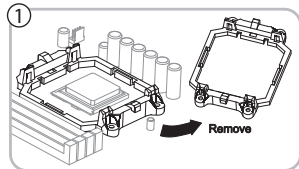

Remove the original retention frame from the motherboard.
将主板上原有的塑胶框拆除。

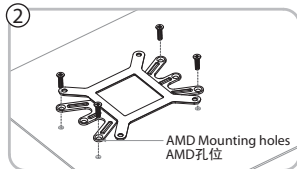

Put the back plate onto the back of the motherboard and insert the thumb screws through the AMD mounting holes.
如图所示，放好背板，将螺丝穿过背板对应的AMD孔位。

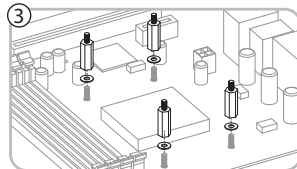

Slip the washers on the thumb screws protruding out of the motherboard, and thread the hex-head nuts on the screws to secure the back plate.
如图所示，将垫片穿过主板上的螺丝，然后用六角螺母锁紧背板。

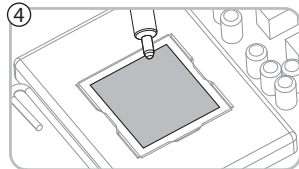

Evenly apply a thin layer of thermal grease onto the processor.
将导热膏均匀涂在CPU表面。

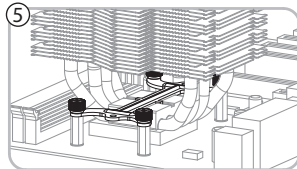

Put the heatsink onto the processor, and put the retention bracket (AMD K8) across the heatsink base, then secure the heatsink by threading the thumb screws into the hex-head nuts.
将散热器主体放在CPU上，注意底部与CPU表面完全接触，然后放入工型扣具AMD K8，使其AMD孔位穿过六角螺母顶端，然后用螺母锁紧工型扣具AMD K8。

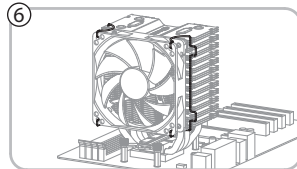

Fix the De-Vibration Buckle onto the fan and attach the fan to the heatsink with wire clips.
用钢丝扣把装好减震器的风扇安装固定在散热器主体一侧。

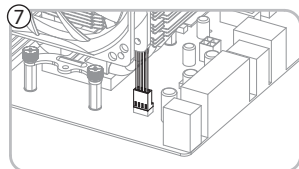

Finish the installation by connecting the fan cable to the motherboard.
将风扇端子插在主板相应位置，确认无误后完成安装。

AMD K8 Installation AMD K8安装步骤

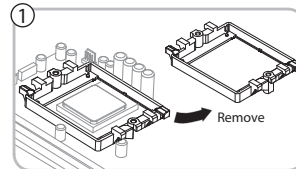

Remove the original retention frame from the motherboard.
将主板上原有的塑胶框拆除。

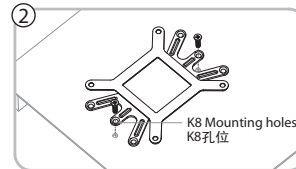

Put the back plate onto the back of the motherboard and insert the thumb screws through the K8 mounting holes.
如图所示，放好背板，将螺丝穿过背板对应的K8孔位。

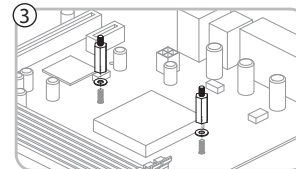

Slip the washers on the thumb screws protruding out of the motherboard, and thread the hex-head nuts on the screws to secure the back plate.
如图所示，将垫片穿过主板上的螺丝，然后用六角螺母锁紧背板。

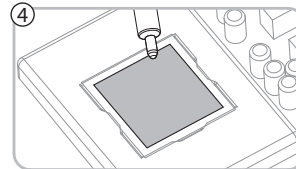

Evenly apply a thin layer of thermal grease onto the processor.
将导热膏均匀涂在CPU表面。

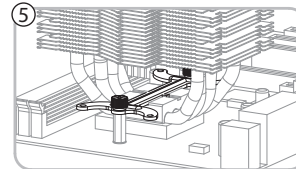

Put the heatsink onto the processor, and put the retention bracket (AMD K8) across the heatsink base, then secure the heatsink by threading the thumb screws into the hex-head nuts.
将散热器主体放在CPU上，注意底部与CPU表面完全接触，然后放入工型扣具AMD K8，使其K8孔位穿过六角螺母顶端，然后用螺母锁紧工型扣具AMD K8。

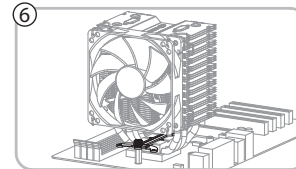

Fix the De-Vibration buffer onto the fan and attach the fan to the heatsink with wire clips.
用钢丝扣把装好减震器的风扇安装固定在散热器主体一侧。

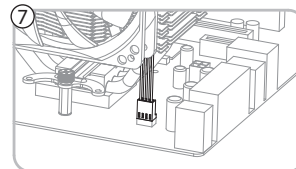

Finish the installation by connecting the fan cable to the motherboard.
将风扇端子插在主板相应位置，确认无误后完成安装。